

Fig. 1

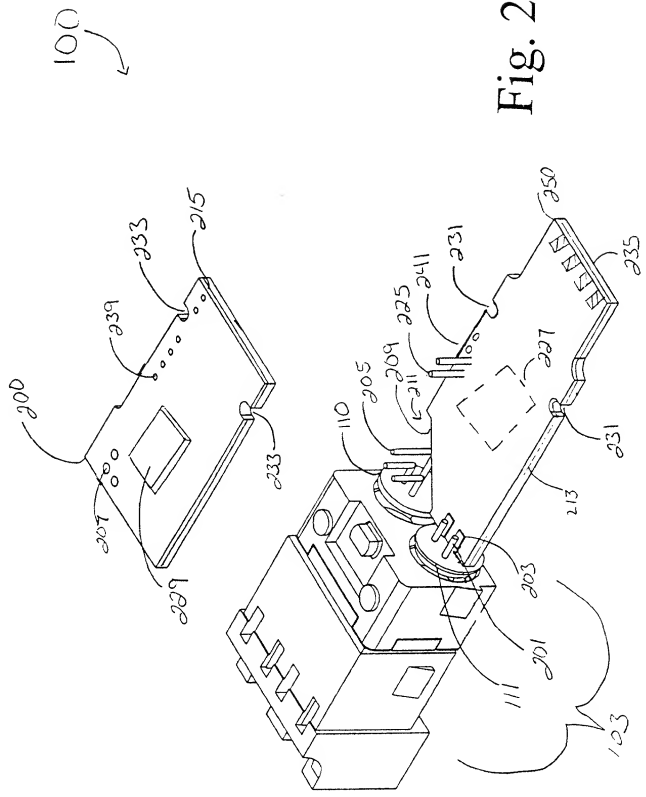

Fig. 2



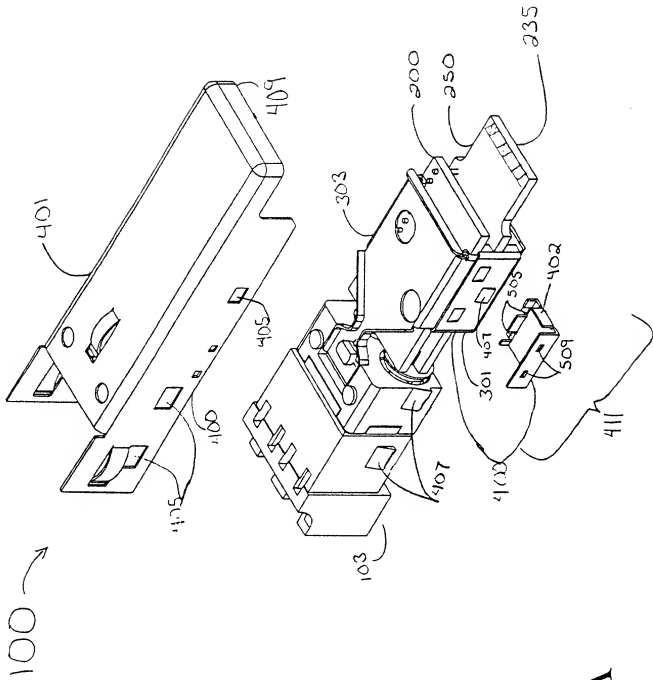

Fig. 4A

204210.465907  
20055394.012402

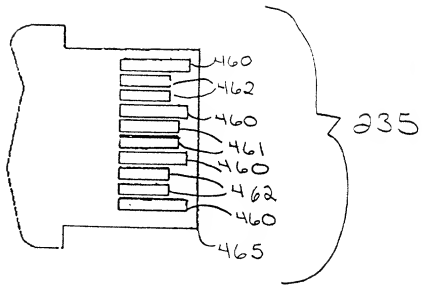

Fig. 4B

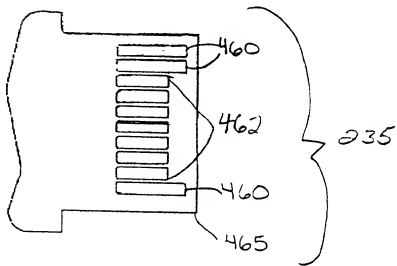

Fig. 4C

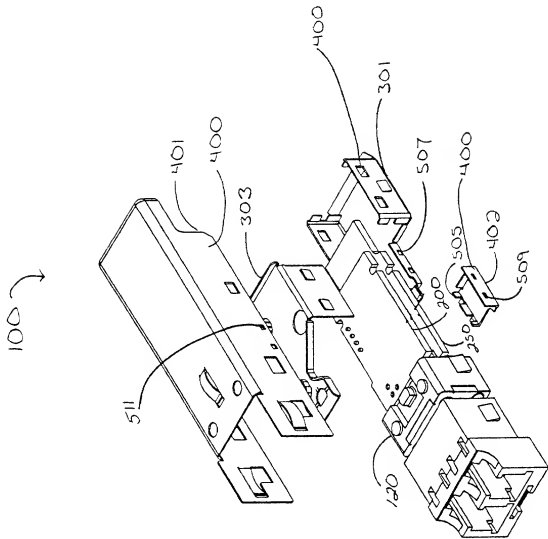

Fig. 5

204210 4669500T

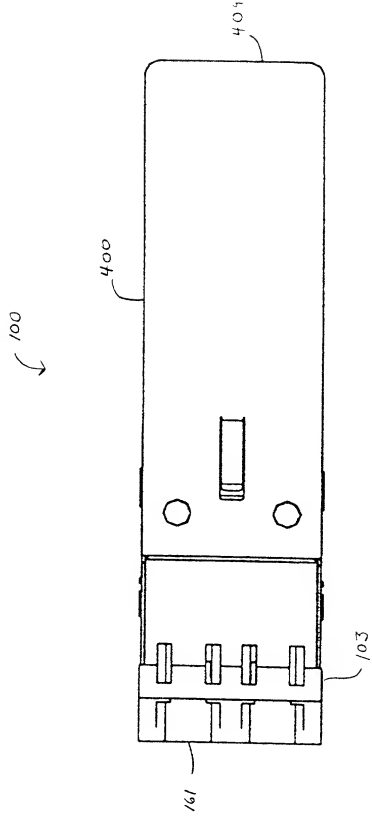

FIGURE 6A

202410-4629001

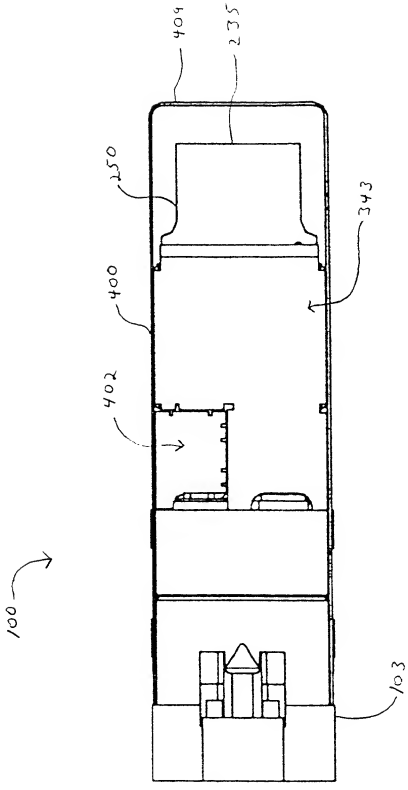

FIGURE 6B



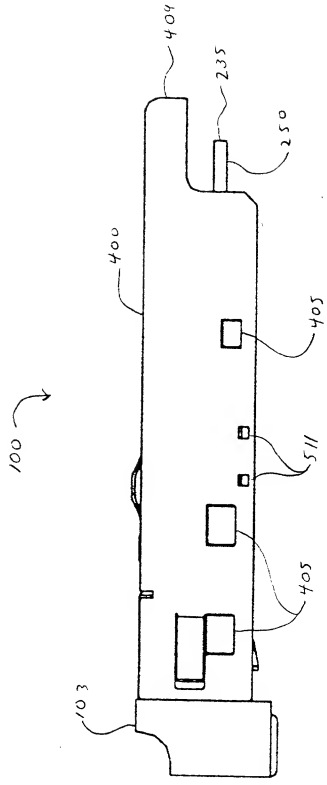

FIGURE 6C

201210146895001

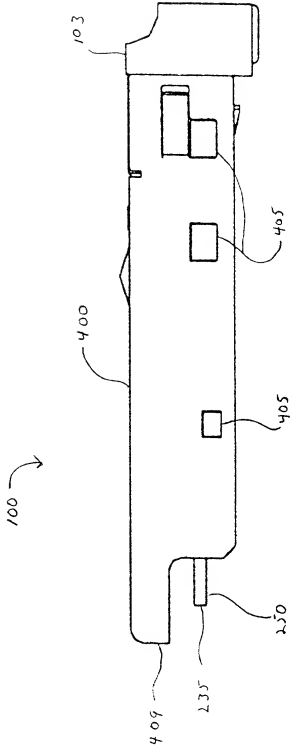

FIGURE 6D

10056394-012402

100 →

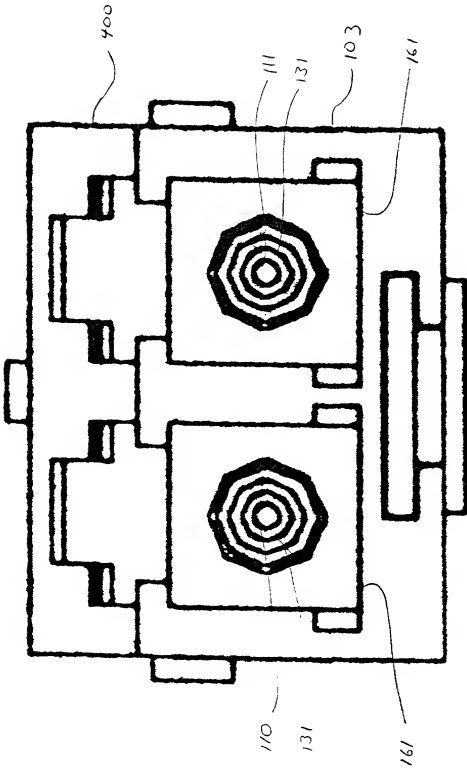

FIGURE 6E

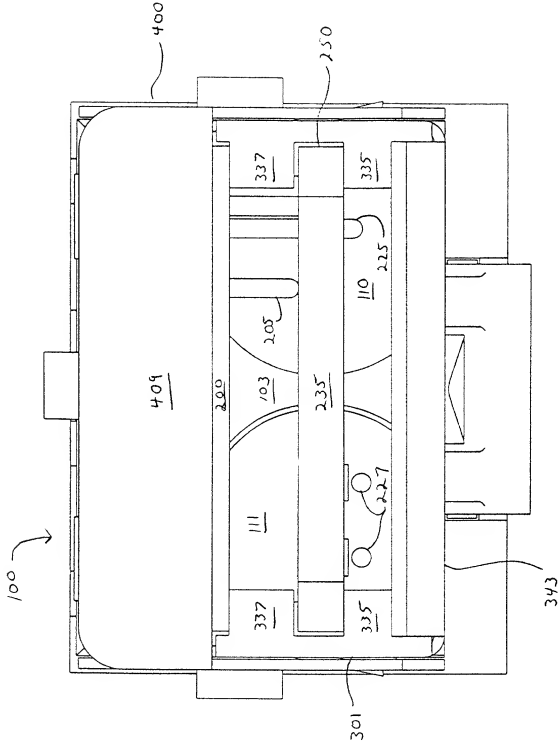
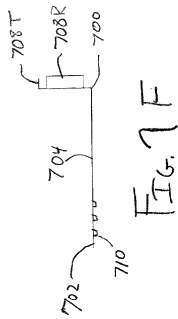
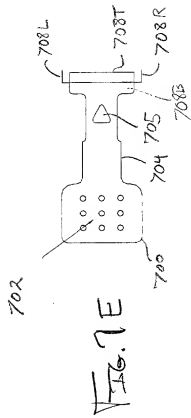
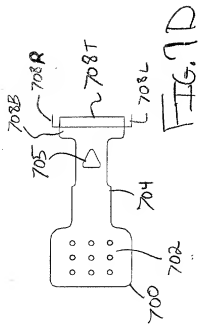
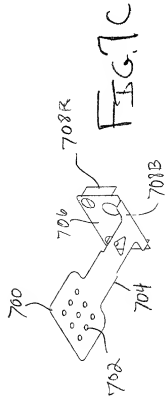
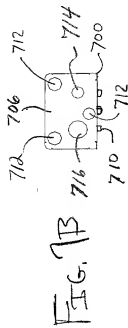
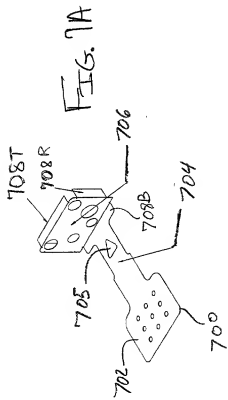

FIG. 6F



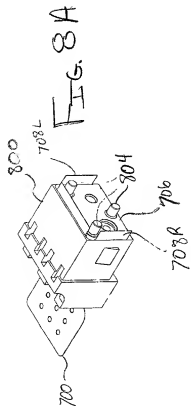

FIG. 8A

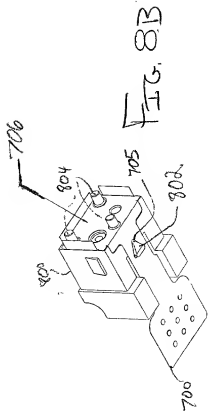

FIG. 8B

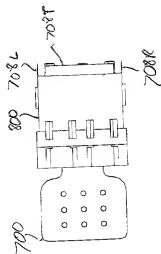

FIG. 8C

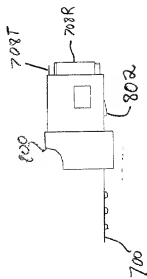

FIG. 8D

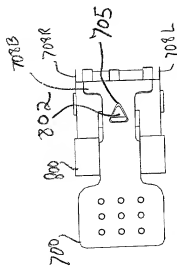

FIG. 8E

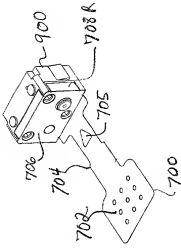

FIG. 9A

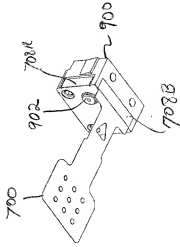

FIG. 9B

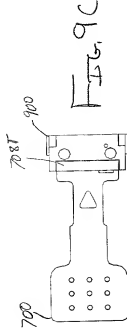

FIG. 9C

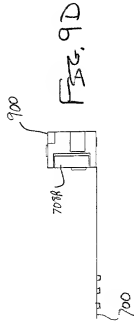

FIG. 9D

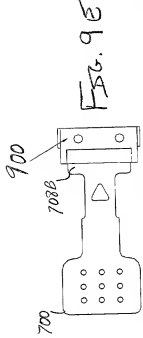
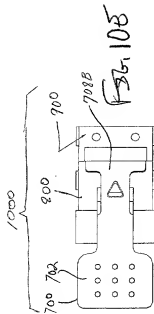
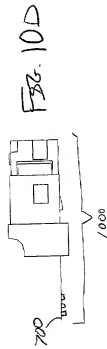
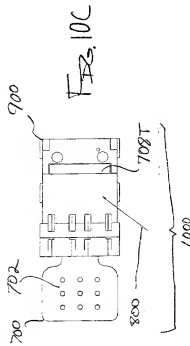
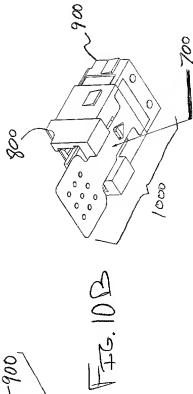
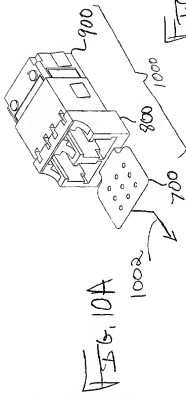
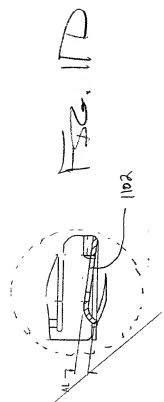
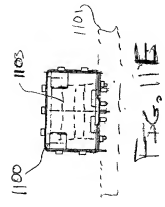
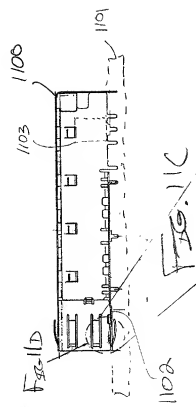
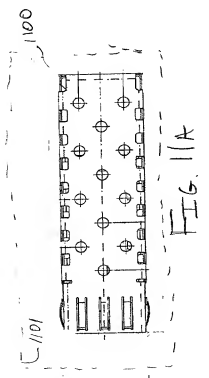
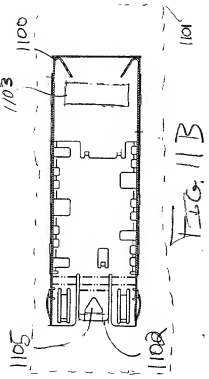

FIG. 9E





204210-46295001



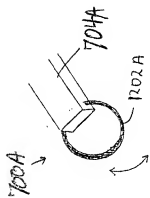

Fig. 12A

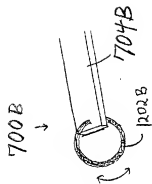

Fig. 12B

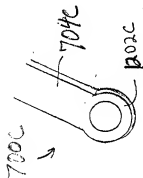

Fig. 12C

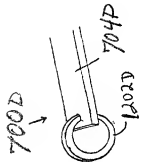

Fig. 12D

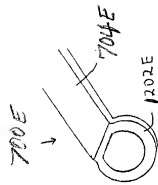

Fig. 12E

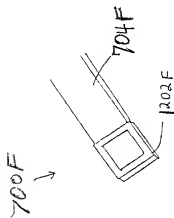

Fig. 12 F

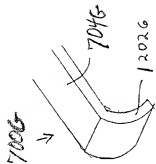

Fig. 12 G

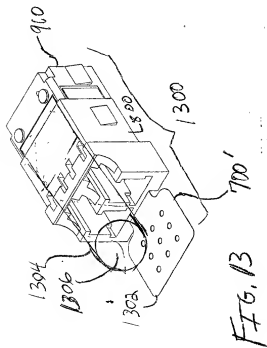

FIG. 13

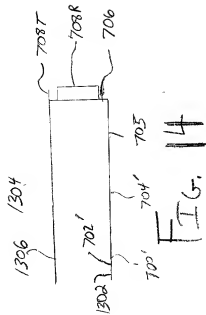

FIG. 14